

Article number: 03003030

Description: Fluro Rod End GIS 30
Zinc Plated

Measures

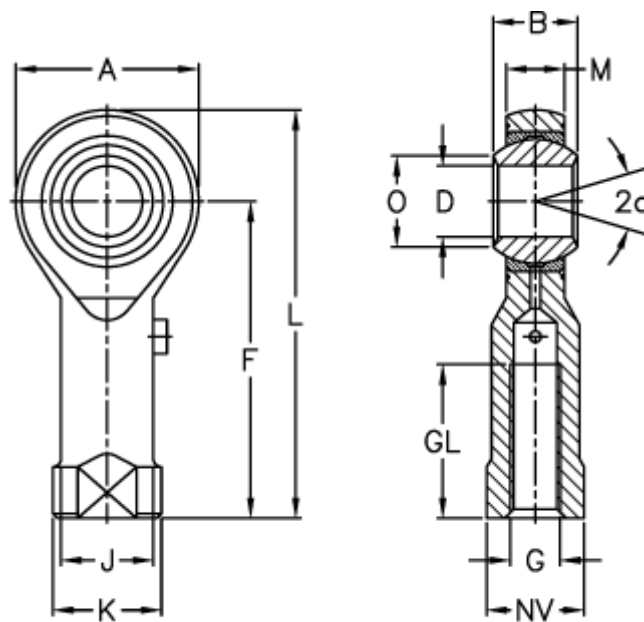

Str. 2-3 uden smørenippel

A	= 70	J	= 40	Weight (g) = 1130
a (degrees)	= 17	K	= 51	
B	= 37	L	= 145	
D	= 30	M	= 25	
Dynamic load C (kN)	= 64	NV	= 41	
F	= 110	O	= 34.8	
G	= M30x2	Permissible rpm	= 370	
GL	= 51	Static load C0 (kN)	= 82	